

Firefighter locker JUNIOR



Variants:

- 1, 2 or 3 compartments
- Execution with increased material thickness
- Different colour variants **see page 4**
- Lockable valuables compartment or open storage:



Equipment:

- 2 plastic hooks
- Oval clothes rail with 3 anti-twist aluminium hooks
- For further optional accessories **see page 3**

Construction:

- Sturdy construction made of torsion-resistant, powder-coated quality sheet steel
- Material thickness corpus: 0.6 mm
- Material thickness of cupboard base / roof: 0.8 mm
- Smooth, easy-to-clean surfaces
- Ventilation slots on the upper edge of the cabinet, optional: perforated cabinet base
- Prepared for wall assembly
- Optional: base with plinth (H 12 cm), fixed or height-adjustable feet (H 12 cm / H 15 cm)

Doors:

- Robust execution due to double bevelling
- Attached to sturdy stainless steel bolts
- Opening angle approx. 110°
- Material thickness: 1.0 mm
- Rubber buffer for noise reduction
- Available locks **see page 4**





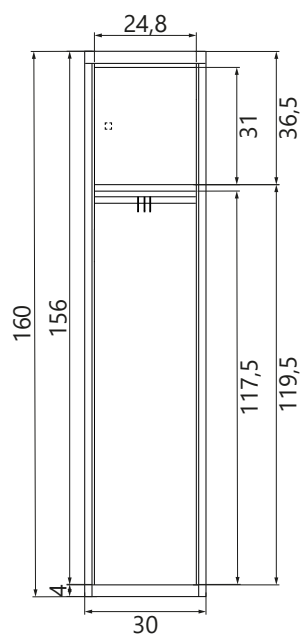

Classification of fire behaviour according to EN 13501-1

The firefighter locker is non-combustible and is assigned to European fire protection class **A2-s1, d0**.

Firefighter locker JUNIOR

Technical drawings and dimensions:



Compartments		Item number	Outer dimension HxWxD in cm	Weight in kg	
Safe deposit box		1	1172-010116-0300012	160x30x50	18
		2	1172-020116-0600012	160x60x50	30
		3	1172-030116-0900012	160x90x50	43
Open shelf		1	1172-010016-0300000	160x30x50	17
		2	1172-020016-0600000	160x60x50	28
		3	1172-030016-0900000	160x90x50	40

Accessories for firefighter locker JUNIOR

fixed helmet holder or
flexible helmet holder



galvanised boot grate



plastic shoe shell



stainless steel clothes
hanger



compartment numbering



socket outlet in the
private compartment



mobile substructure



rail system for
wall assembly

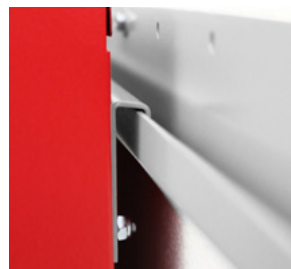

freestanding
fire brigade benches



Locks and colours for firefighter lockers

Locks

The private and valuables compartments of the firefighter lockers can be equipped with various locks. We offer a wide range of different locks. The models shown are examples and only show one variant in each case.

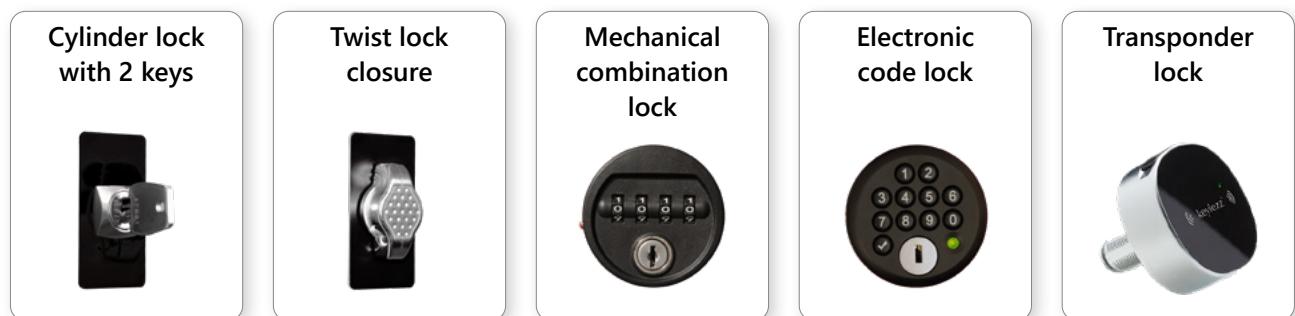

Colour variants

All firefighter lockers are finished with a high-quality powder coating. The RAL colours listed below are available for painting the corpus and doors. To provide long-lasting corrosion protection, we also recommend additional galvanising.



Other colour variants are available at an extra charge.